

Light efficiency:

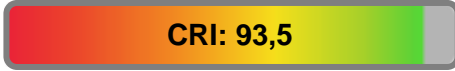

Light quality:



Color temperature:



Output: 374 lm

Peak: 118 cd

Power: 5,4 W

PF: 1,0

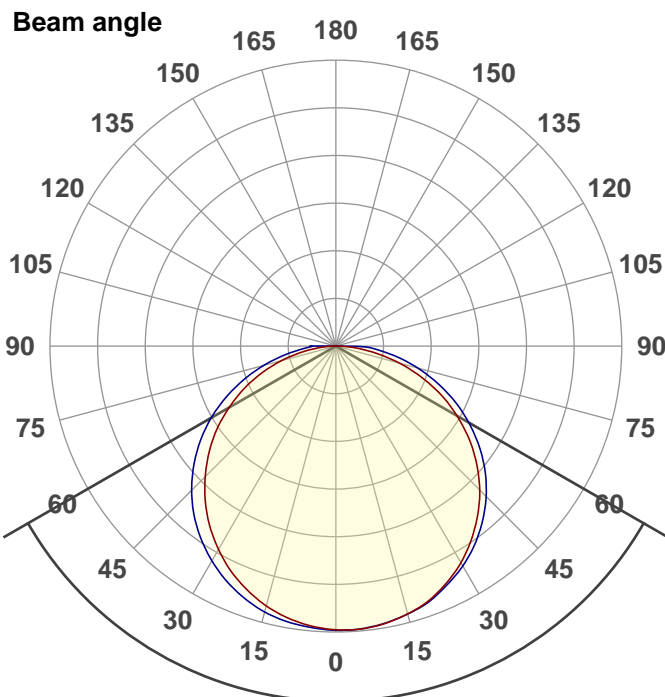
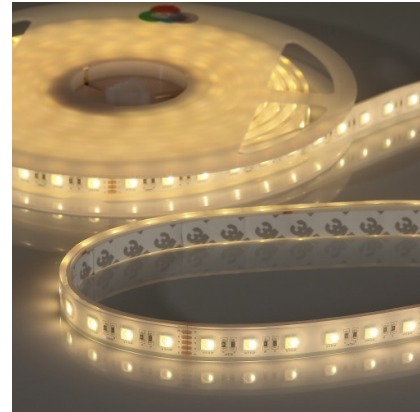

Product name:

**Flex Stripe 24V, 19.2W, RGBW\_2700K, CRI90, 60LED, IP68, 14.5mm,#1**

Item number:

**E10014**

Date and time:

**26.05.2020 14:49:43**

Description:

Spectra

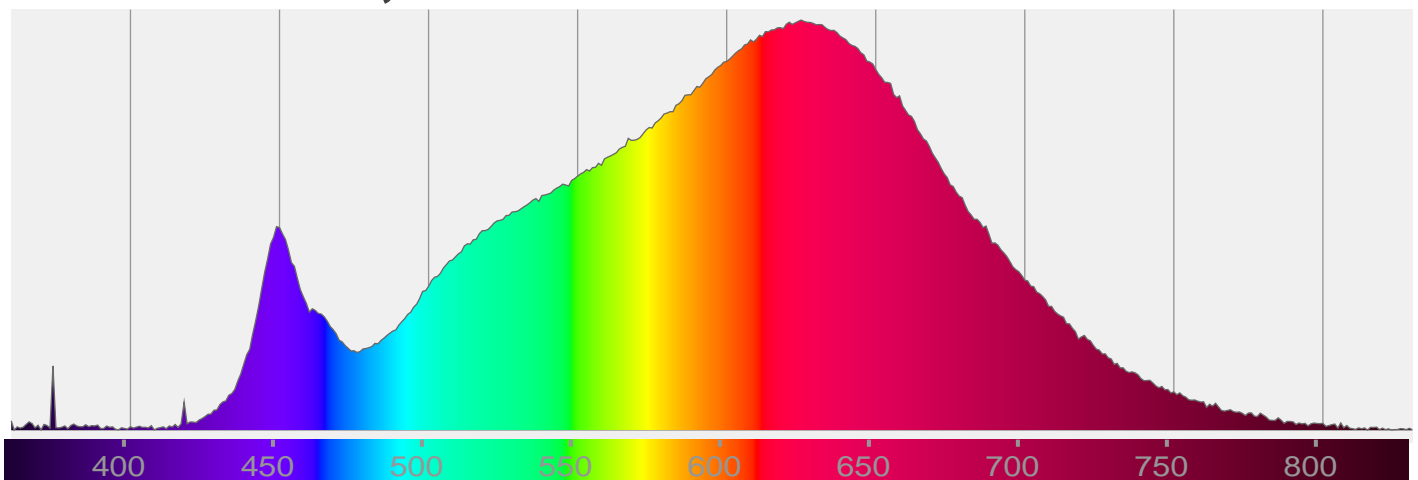

Dominante Wellenlänge: 625 und 449

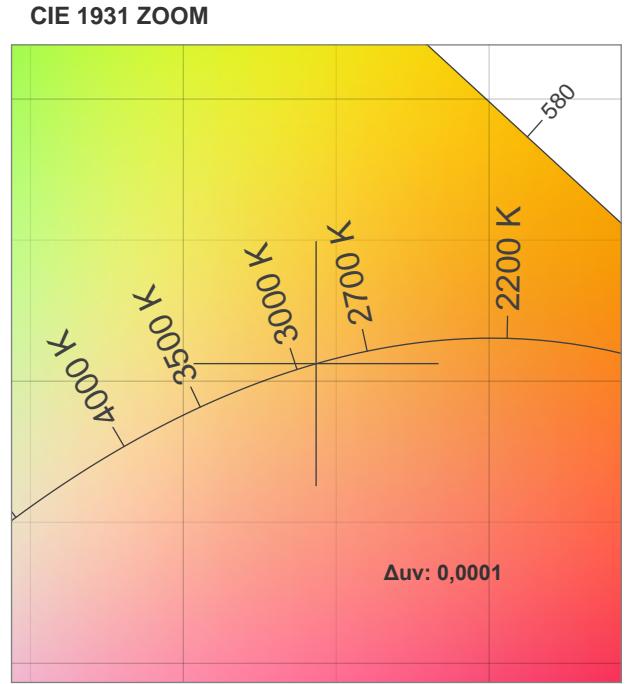
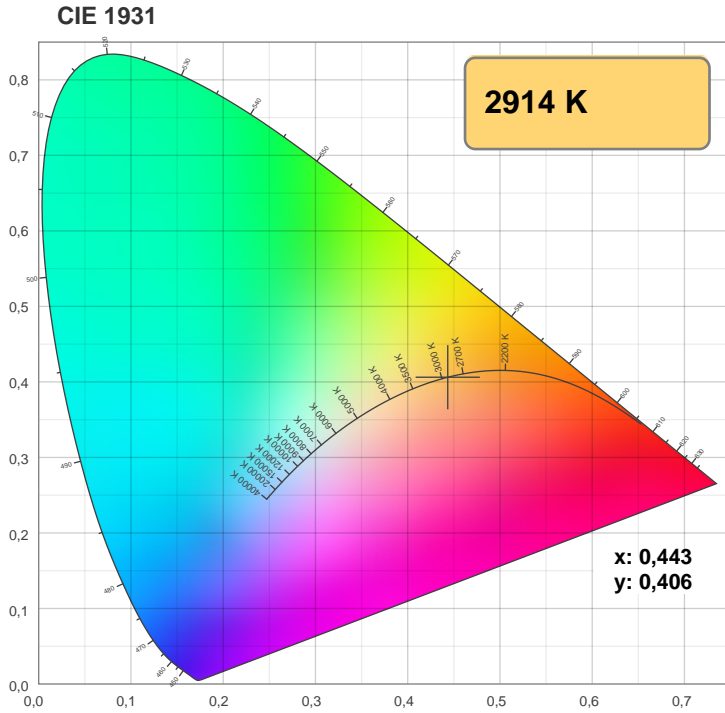

**TM-30: 92,5**

**CRI: 93,5 (R1-R8)**

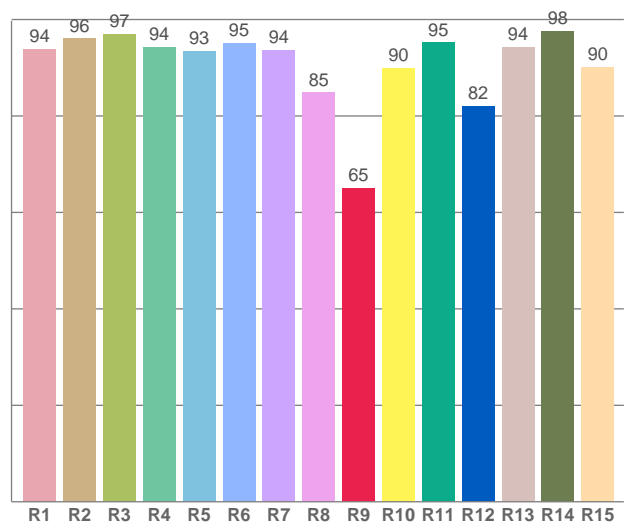
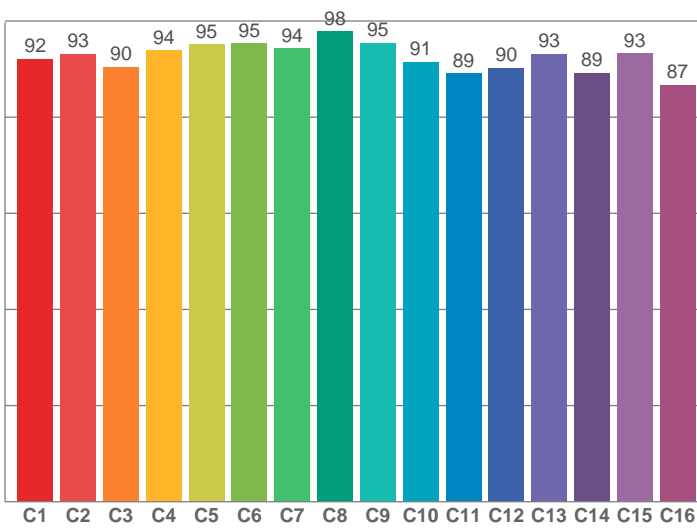

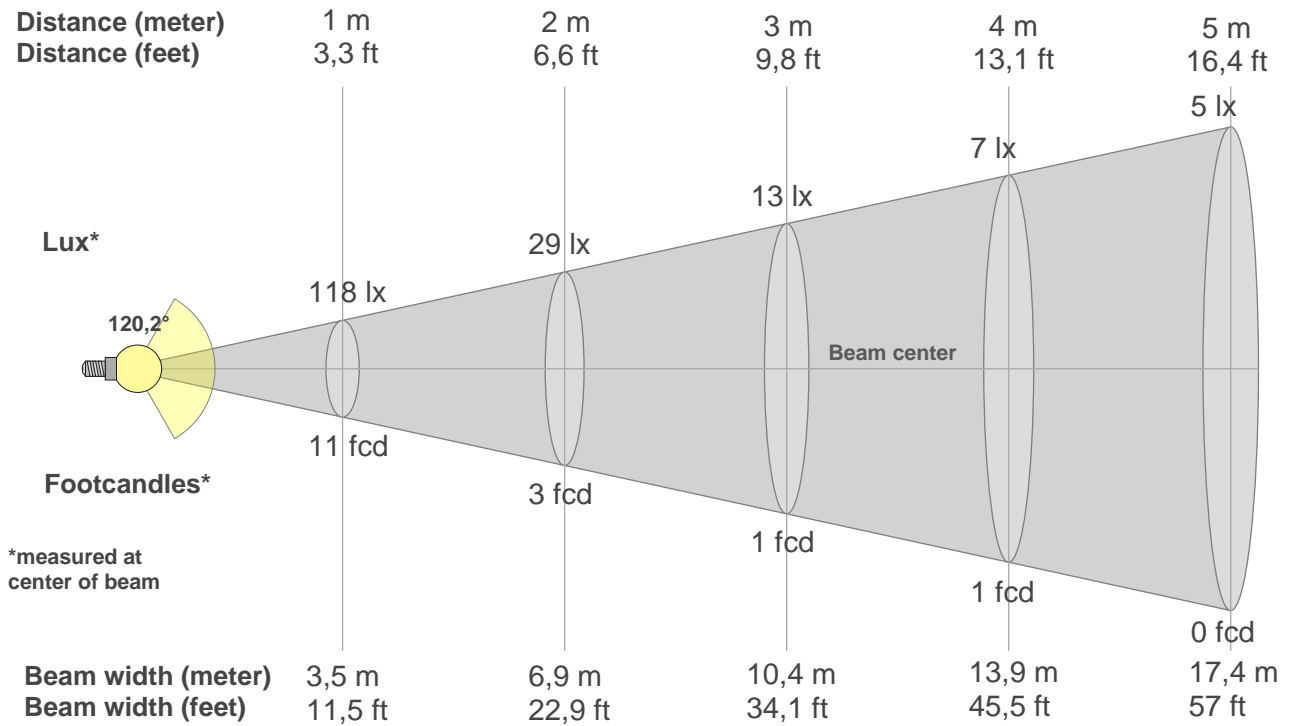

Light efficiency:

**26 Lumen/Watt**

Light quality:

**CRI: 0,0**

Color temperature:

**0 K**

**CIE 1931: x: 0,692 y: 0,304**

**Output: 135 lm**  
**Peak: 40,6 cd**  
**Power: 5,1 W**  
**PF: 1,0**

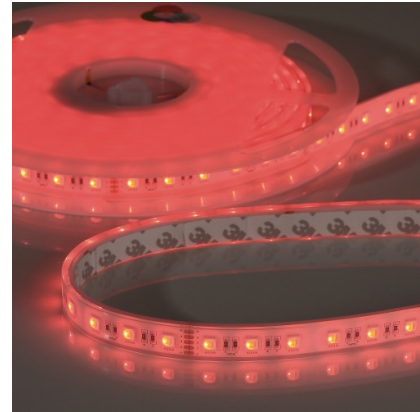

Product name:  
**Flex Stripe 24V, 19.2W, RGBW\_2700K, CRI90, 60LED, IP68, 14.5mm,#2**  
Item number:  
**E10014**  
Date and time:  
**26.05.2020 14:52:13**  
Description:

Beam angle

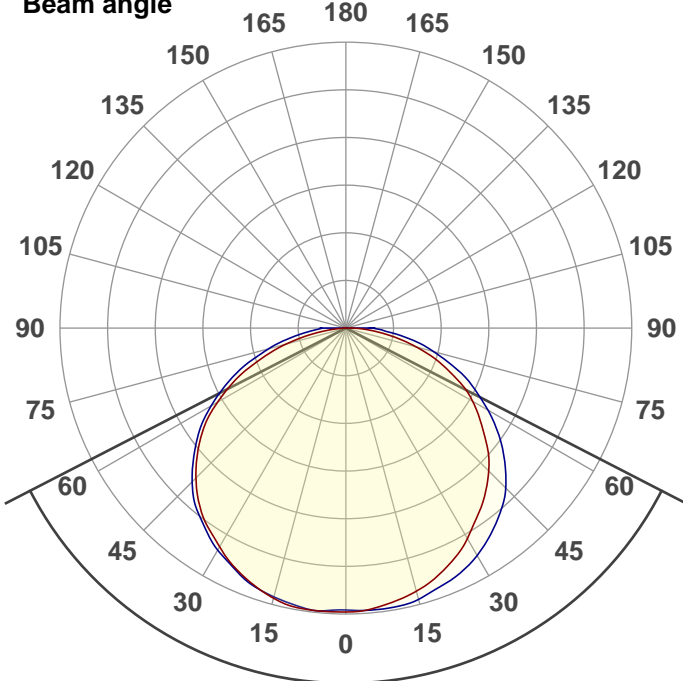

Spectra

**125,5°**

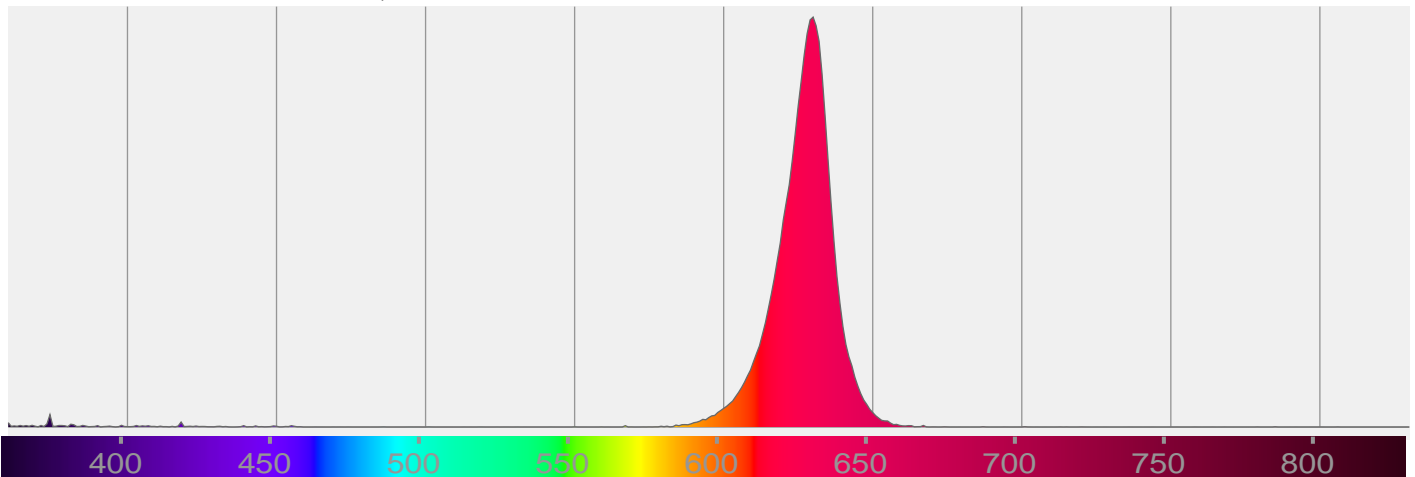

Dominante Wellenlänge: 630 und n/a



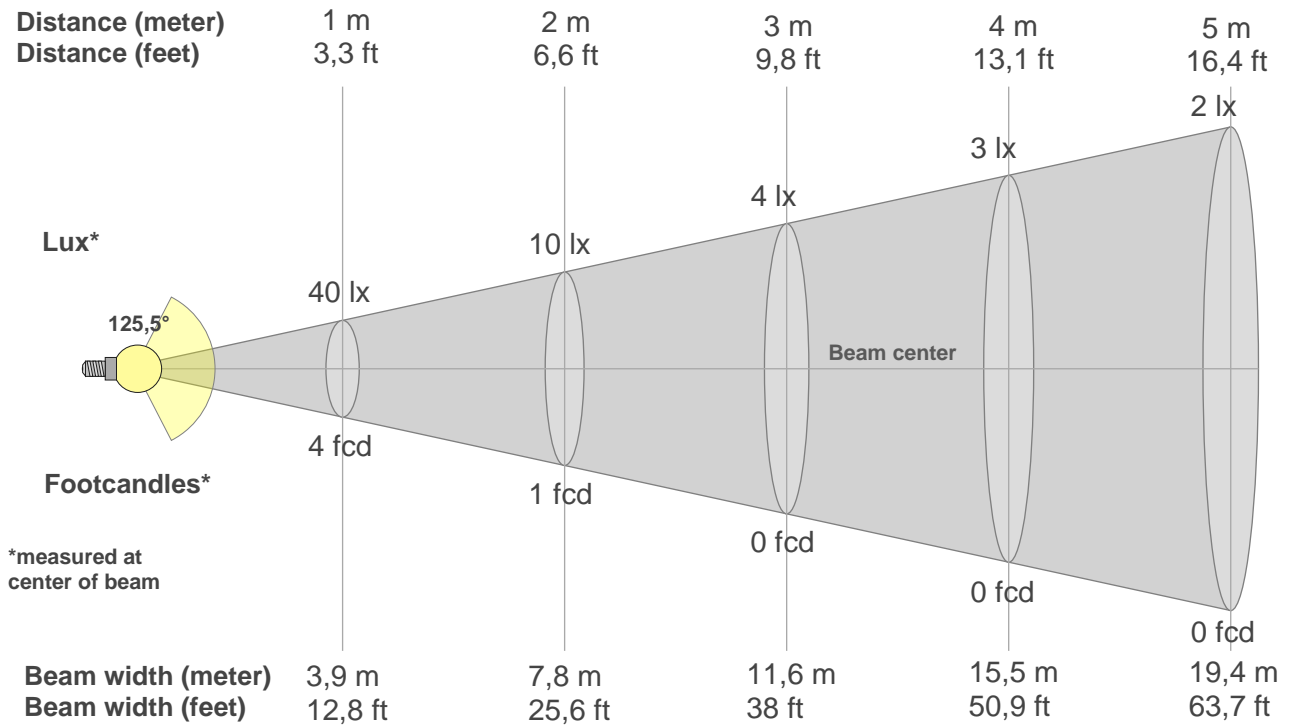

Light efficiency:



Light quality:



Color temperature:

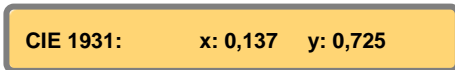

**Output:** 366 lm  
**Peak:** 99,3 cd  
**Power:** 4,8 W  
**PF:** 1,0

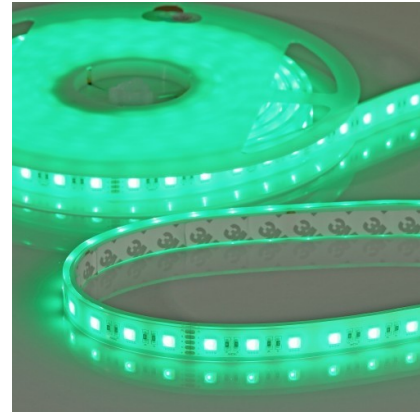

Product name:  
**Flex Stripe 24V, 19.2W, RGBW\_2700K, CRI90, 60LED, IP68, 14.5mm,#3**  
Item number:  
**E10014**  
Date and time:  
**26.05.2020 14:56:34**  
Description:

Beam angle

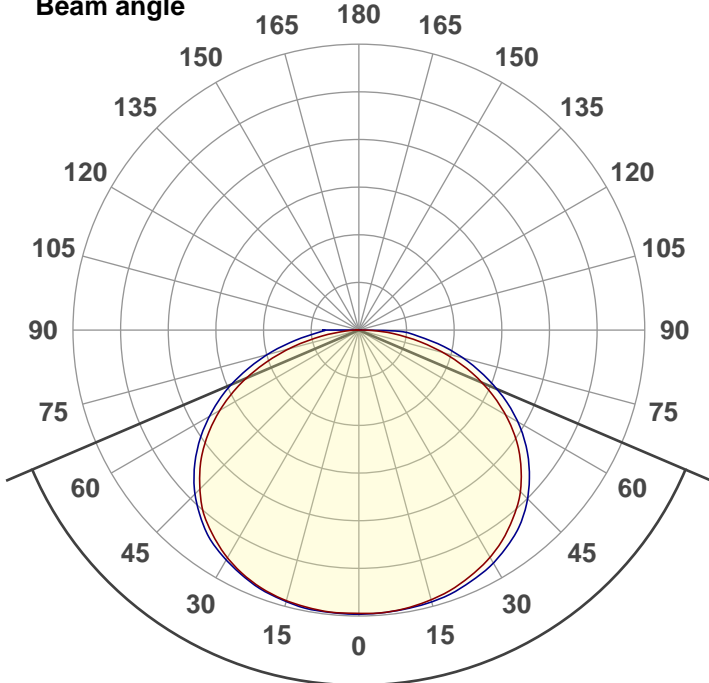

Spectra

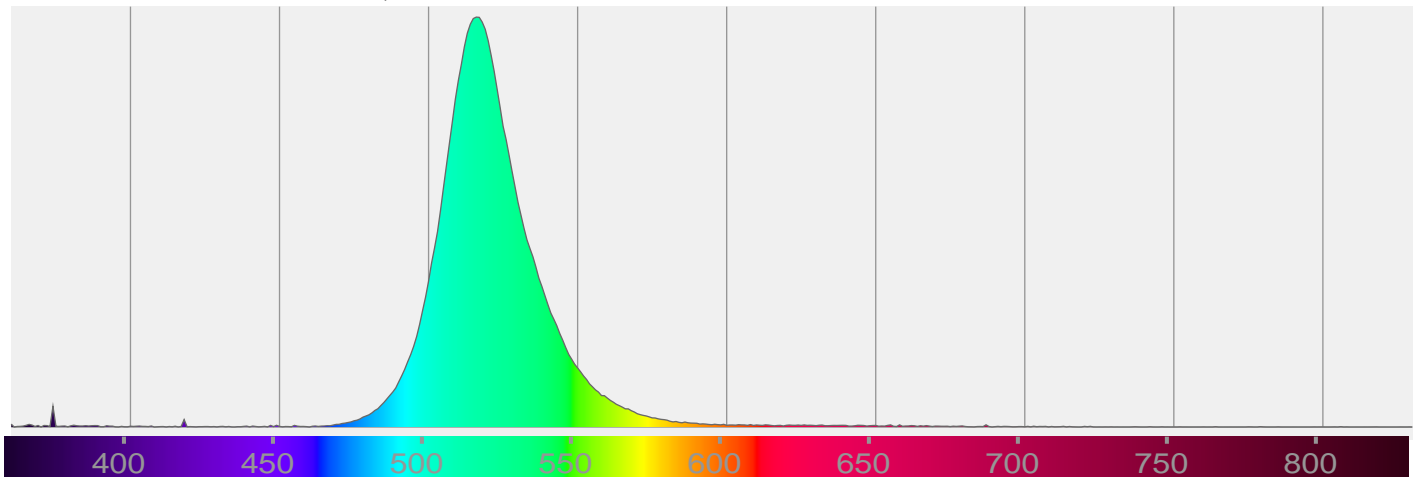

Dominante Wellenlänge: 516 und 374



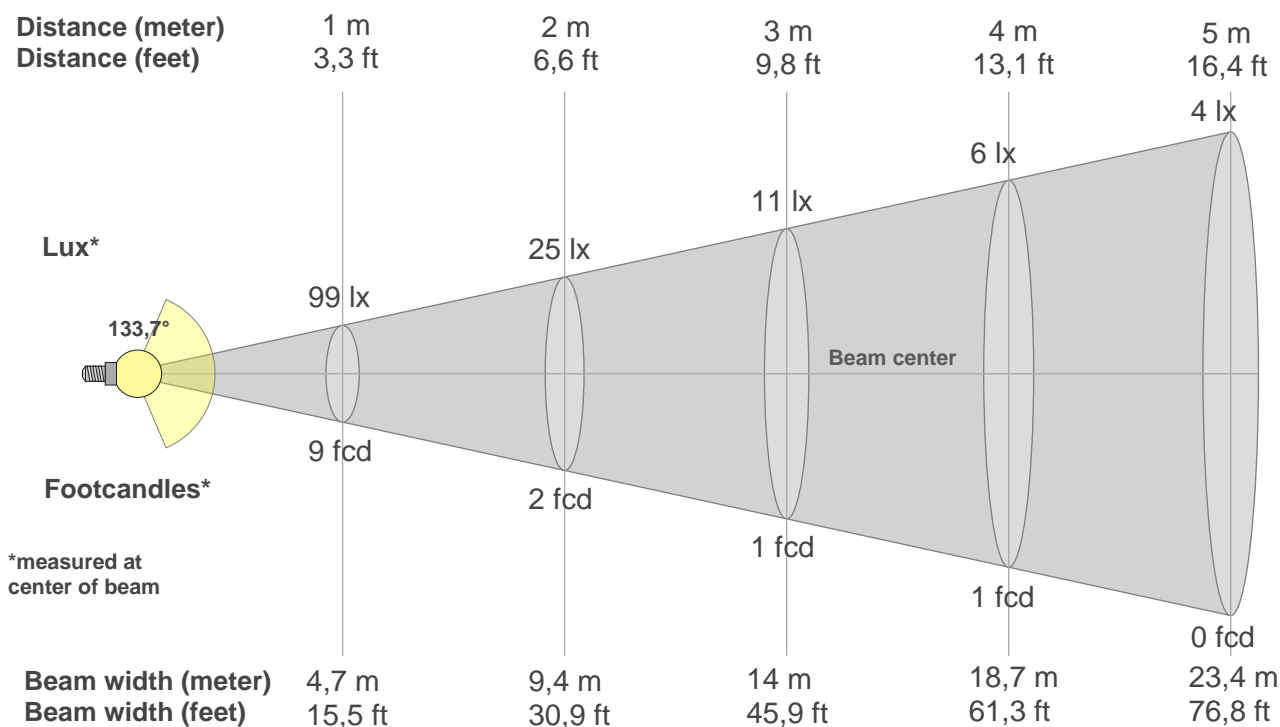

Light efficiency:



Light quality:



Color temperature:

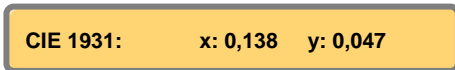

Output: 73,1 lm

Peak: 21,7 cd

Power: 5,0 W

PF: 1,0

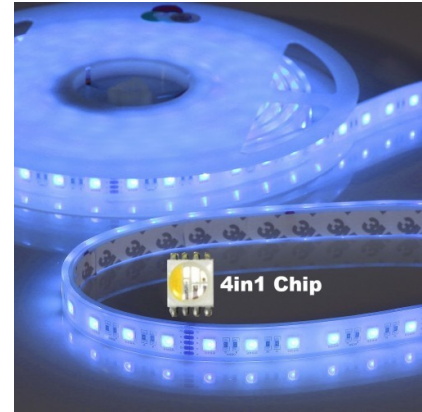

Product name:

**Flex Stripe 24V, 19.2W, RGBW\_2700K, CRI90, 60LED, IP68, 14.5mm,#4**

Item number:

**E10014**

Date and time:

**26.05.2020 14:58:30**

Description:

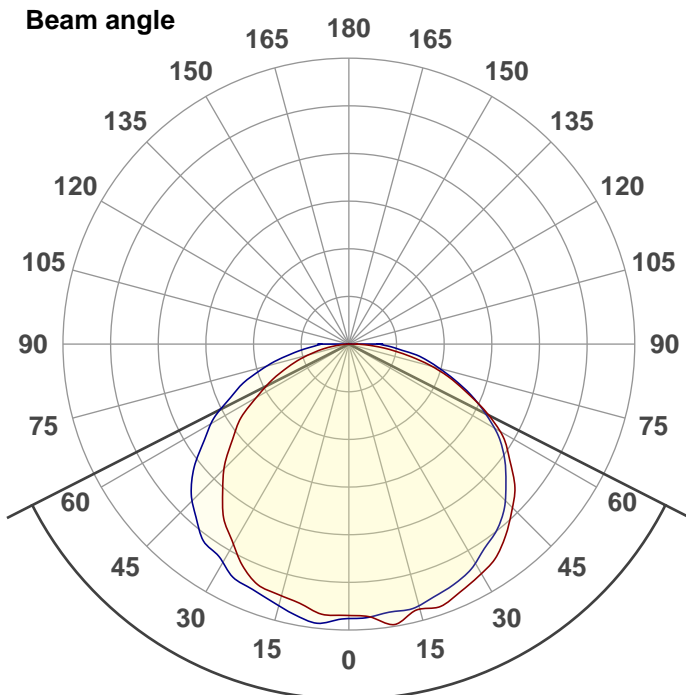

Spectra

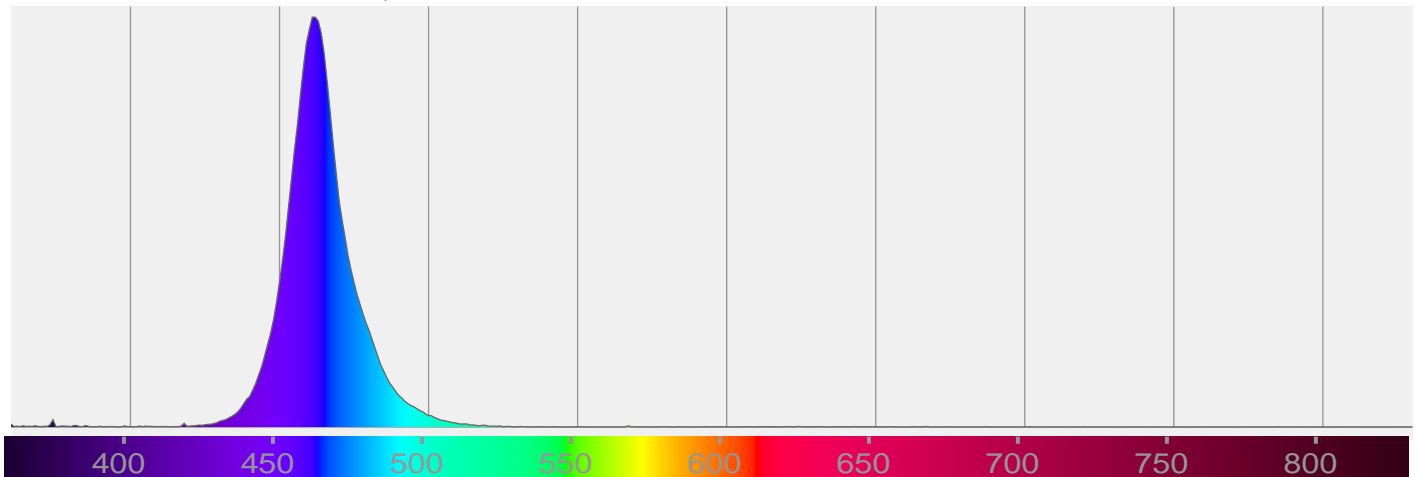

Dominante Wellenlänge: 461 und n/a

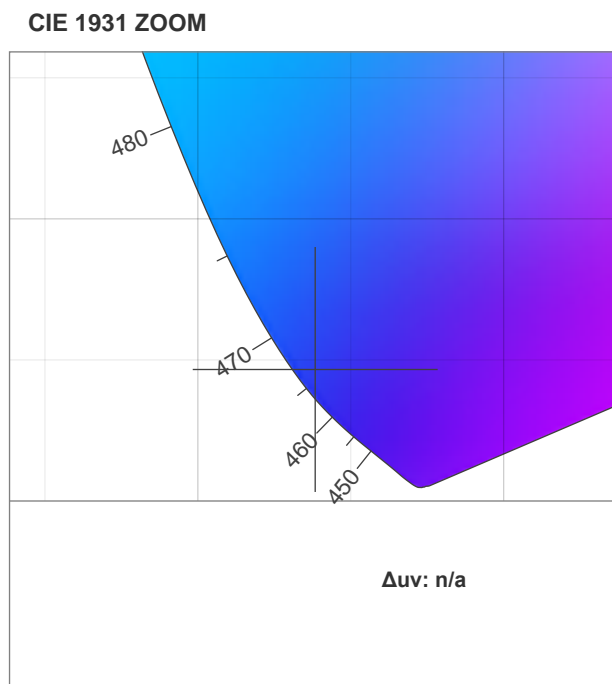
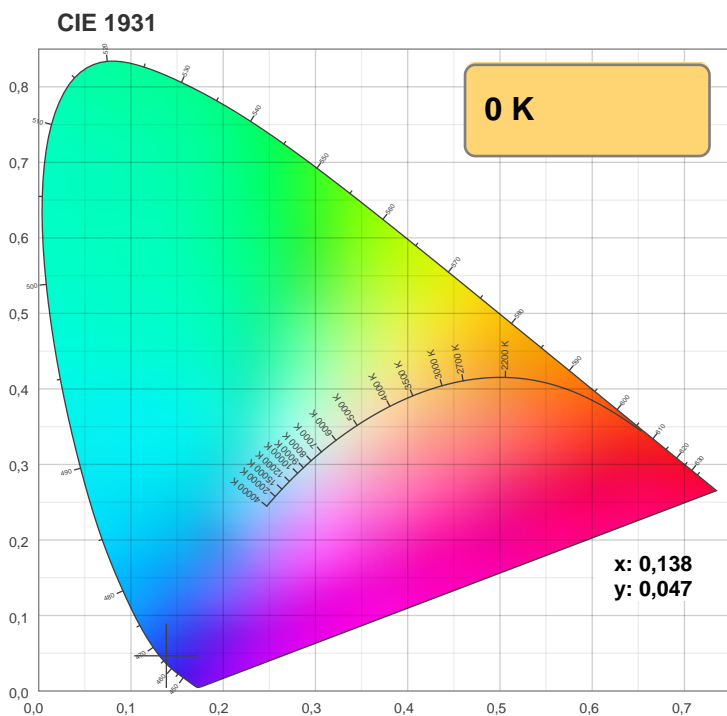

**TM-30: 0,0**

**CRI: 0,0 (R1-R8)**

0	0	0	0	0	0	0	0	0	0	0	0	0	0	0	0
C1	C2	C3	C4	C5	C6	C7	C8	C9	C10	C11	C12	C13	C14	C15	C16

0	0	0	0	0	0	0	0	0	0	0	0	0	0	0	0
R1	R2	R3	R4	R5	R6	R7	R8	R9	R10	R11	R12	R13	R14	R15	

